

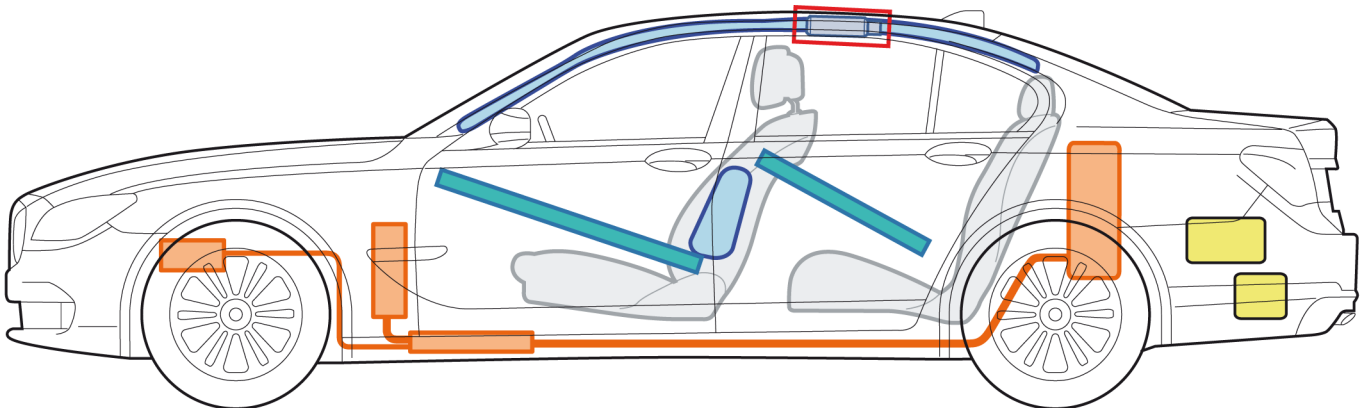

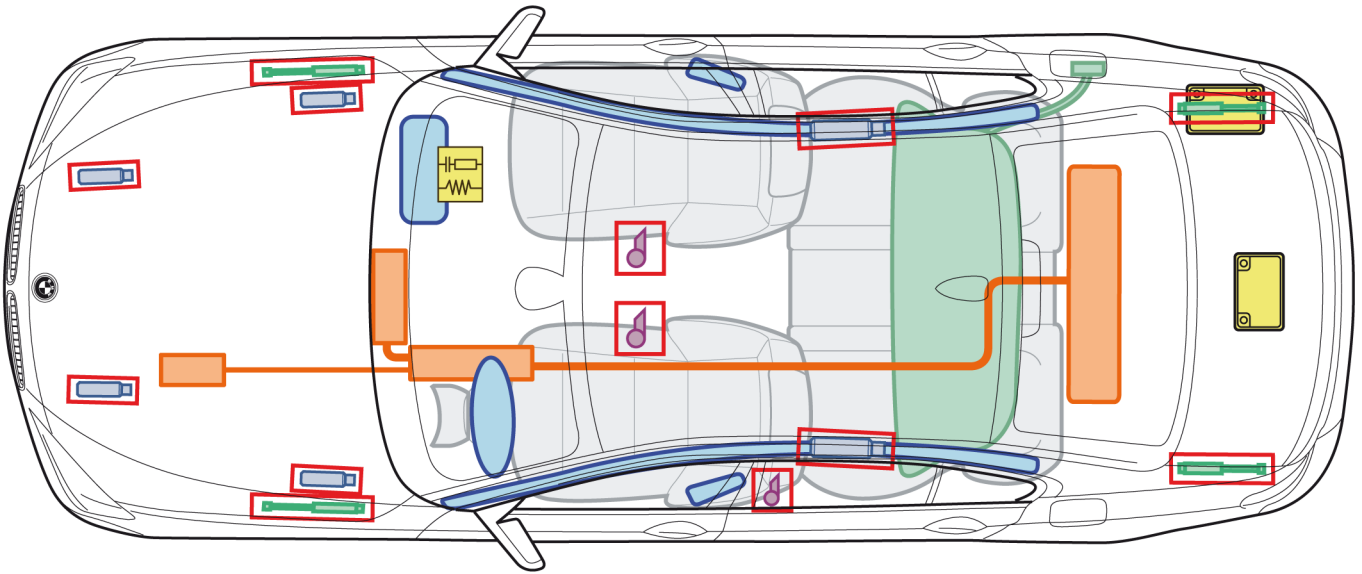







7 Series ActiveHybrid 7 F01/ F02

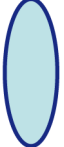

(from 07/2012)



Legend

	Airbag		Body reinforcement		Airbag control unit
	Gas generator		Gas-filled shock absorber		12 V battery
	Belt tensioner		Fuel tank		High-voltage components

This overview shows the maximum possible vehicle equipment.



Danger to life!

Do not touch high-voltage components!

Special features:

High-voltage system with direct current voltage up to 385 volts!

Identifying features and details below.



Identifying features:

"ActiveHybrid 7" lettering on tailgate, side panel and door sill cover strip.

Secure vehicle to prevent it rolling.



Press "P" button.



Pull the switch for the electrical Automatic Hold brake up.



Airbag activated

The high-voltage system is automatically deactivated (de-energised) if an accident is experienced that triggers the airbags.

Deactivate the electric motor and high-voltage system (switch to de-energised) Variant 1 - Airbag not activated.

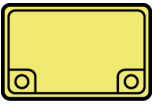

Remarks:

The negative terminals of the 12 V batteries must always be disconnected.

Disconnecting the negative terminals of all 12 V batteries will automatically deactivate (de-energise) the high-voltage system.

(Ignition and 12 V batteries are accessible)



1. Press the start/stop button while the engine is running. Engine stalls.

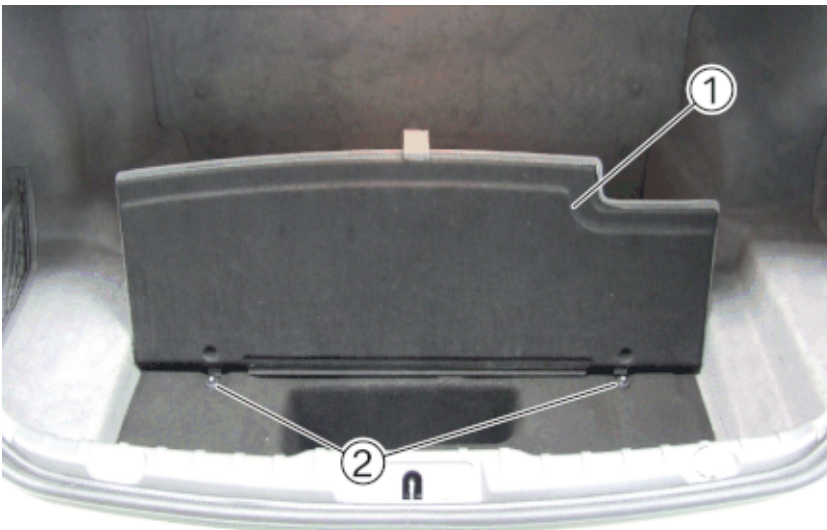

2. Open the tailgate and fold the luggage compartment floor trim panel (1) up. Loosen plastic nuts (2) and remove luggage compartment floor trim panel (1).

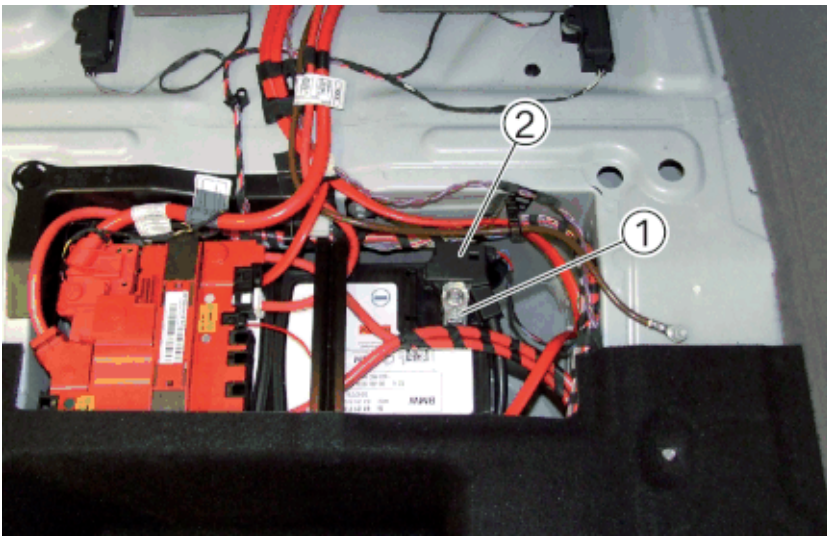

3. Loosen the nut (1) and pull the battery earth lead (2) off toward the top. Cover the battery earth lead, in order to prevent contact to the battery terminals.

Disconnect 12 V auxiliary battery.

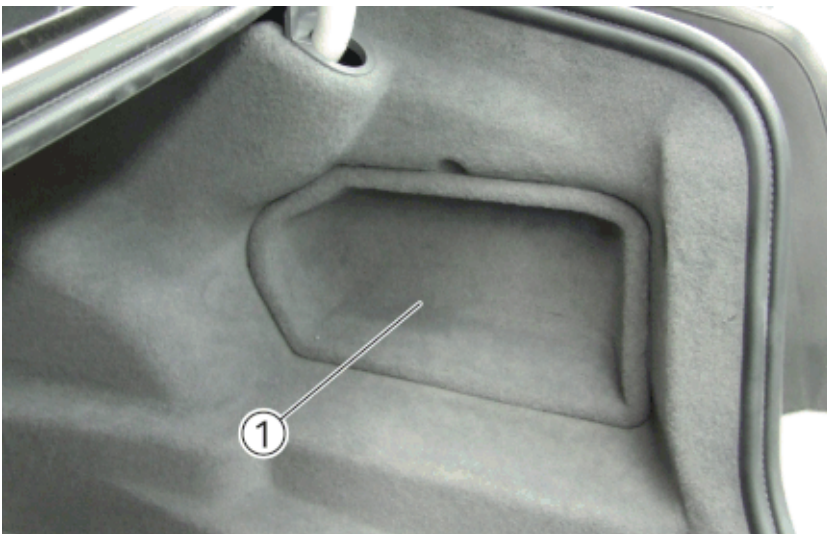

Remove service flap (1) from luggage compartment trim panel on the right.



Loosen the nut and pull the battery earth lead (1) off toward the top. Cover the battery earth lead, in order to prevent contact to the battery terminals.

Deactivate the high-voltage system (switch to de-energised) Variant 2

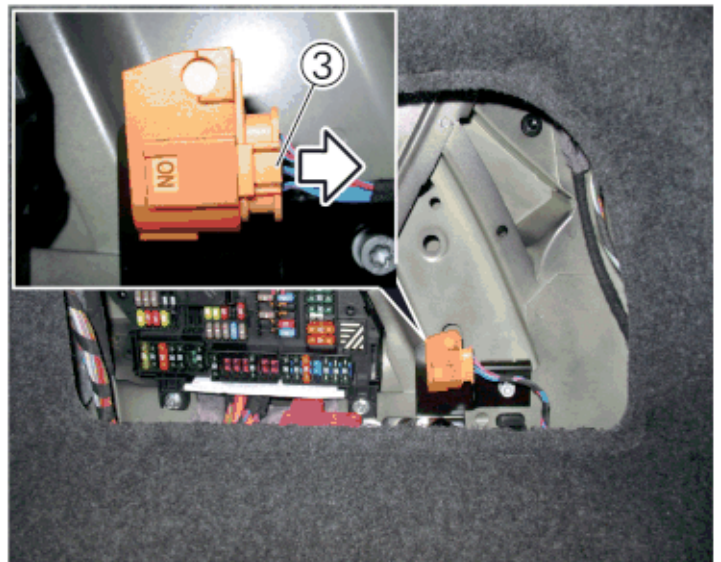
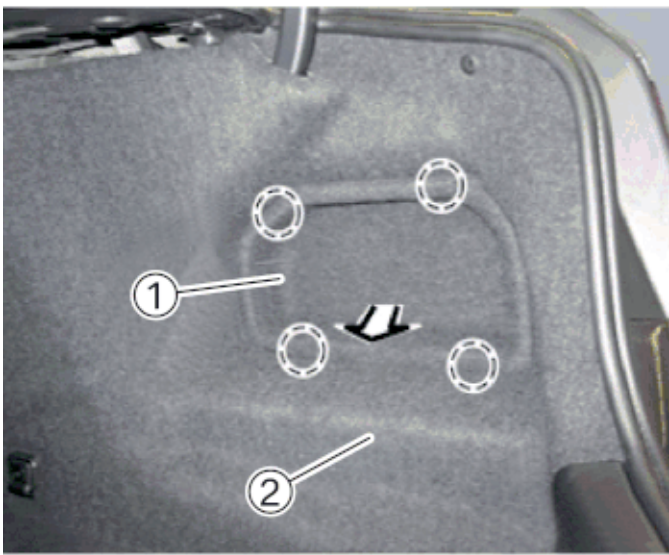

1. Open luggage compartment.
2. Remove service flap (1) from luggage compartment trim panel on the right (2).
3. Release connector from the high-voltage safety connector (Service Disconnect) (3) and pull apart in direction of arrow.

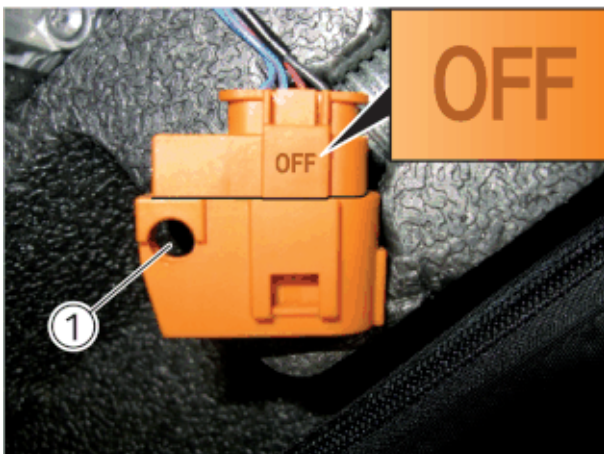

The high-voltage system is deactivated when bore hole (1) is completely free and the word "OFF" can be seen on the connector.

For example, you can install a padlock through the open bore hole (1) to prevent unintended activation of the high-voltage system!

NOTE: The plug connection cannot be fully disconnected.

The high-voltage battery is located underneath the luggage compartment trim panel.

Identification of high-voltage battery:

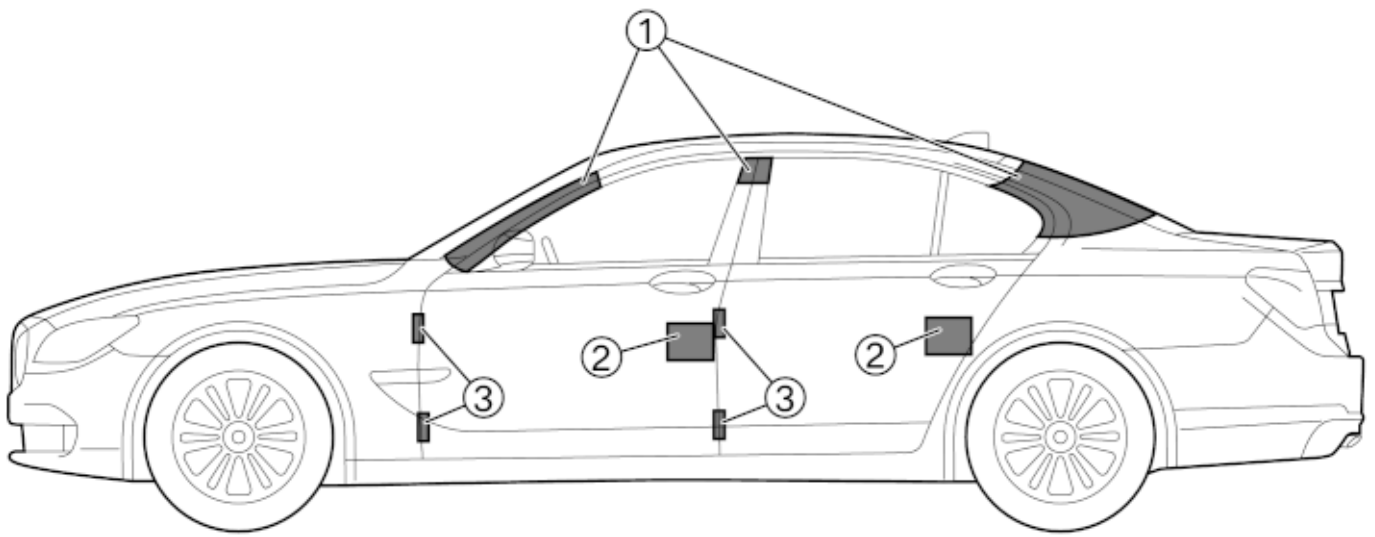

1. The areas mark the zones at which the roof can be cut off.

Modern heavy duty cutting equipment is mandatory for cutting the body; older hydraulic cutting tools could be overloaded.

The heavy duty cutting equipment must be properly used by trained and qualified personnel.

2. Door locks

3. Door hinges

Important information

The information for the rescue personnel needs to be adhered to, see rescue manual.